

#1

ID: 5207e508

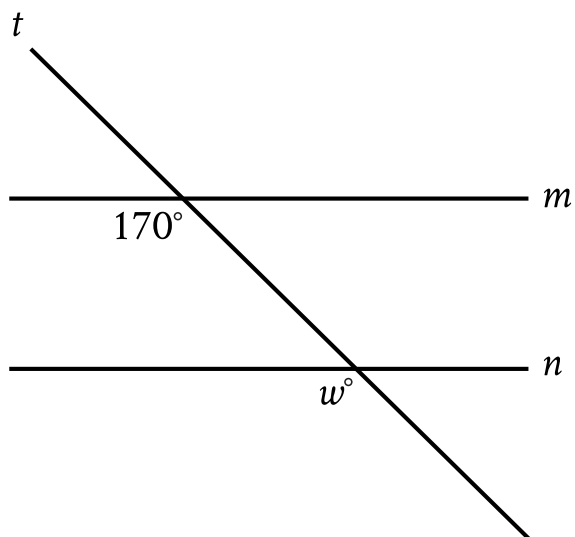

Note: Figure not drawn to scale.

In the figure, line  $m$  is parallel to line  $n$ . What is the value of  $w$ ?

- A) 17
- B) 30
- C) 70
- D) 170

#2

ID: c8d60e48

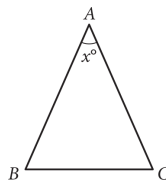

In the given triangle,  $AB = AC$  and  $\angle ABC$  has a measure of  $67^\circ$ . What is the value of  $x$  ?

- A) 36
- B) 46
- C) 58
- D) 70

#3

ID: d5f349b7

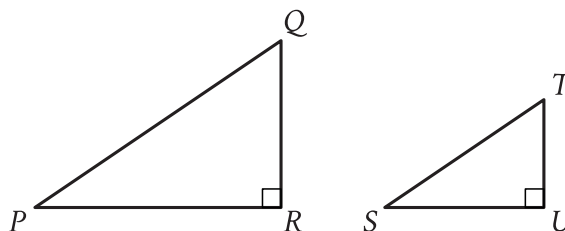

Note: Figures not drawn to scale.

Right triangles  $PQR$  and  $STU$  are similar, where  $P$  corresponds to  $S$ . If the measure of angle  $Q$  is  $18^\circ$ , what is the measure of angle  $S$ ?

- A)  $18^\circ$
- B)  $72^\circ$
- C)  $82^\circ$
- D)  $162^\circ$

#4

ID: a6dbad6b

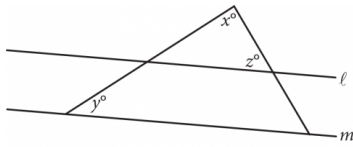

Note: Figure not drawn to scale.

In the figure above, lines  $l$  and  $m$  are parallel,  $y = 20$ , and  $z = 60$ . What is the value of  $x$  ?

- A) 120
- B) 100
- C) 90
- D) 80

#5

ID: cbe8ca31

In  $\triangle XYZ$ , the measure of  $\angle X$  is  $24^\circ$  and the measure of  $\angle Y$  is  $98^\circ$ . What is the measure of  $\angle Z$ ?

- A)  $58^\circ$
- B)  $74^\circ$
- C)  $122^\circ$
- D)  $212^\circ$

#6

ID: c24e1bda

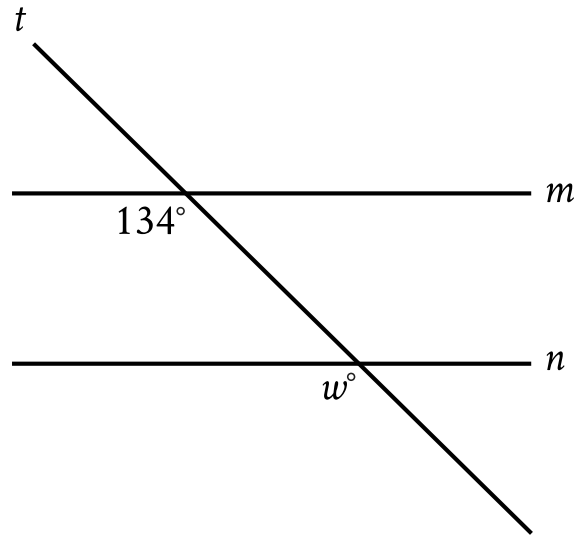

Note: Figure not drawn to scale.

In the figure, line  $m$  is parallel to line  $n$ . What is the value of  $w$ ?

- A) 13
- B) 34
- C) 66
- D) 134

#7

ID: f9d40000

In  $\triangle XYZ$ , the measure of  $\angle X$  is  $23^\circ$  and the measure of  $\angle Y$  is  $66^\circ$ . What is the measure of  $\angle Z$ ?

- A)  $43^\circ$
- B)  $89^\circ$
- C)  $91^\circ$
- D)  $179^\circ$

#8

ID: 0d3f51dc

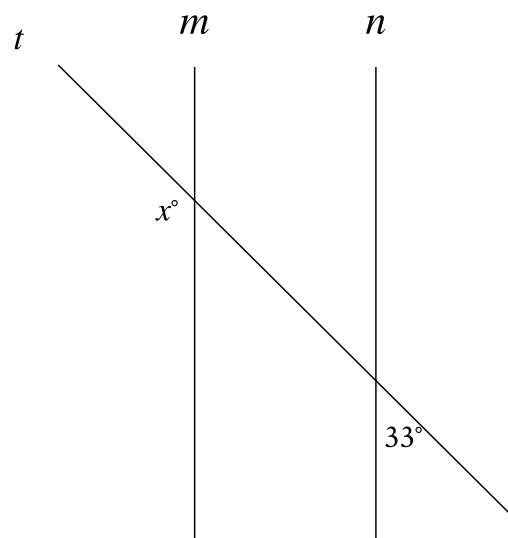

Note: Figure not drawn to scale.

In the figure, line  $m$  is parallel to line  $n$ , and line  $t$  intersects both lines. What is the value of  $x$ ?

- A) 33
- B) 57
- C) 123
- D) 147

#9

ID: b434e103

In  $\triangle RST$ , the measure of  $\angle R$  is  $63^\circ$ . Which of the following could be the measure, in degrees, of  $\angle S$ ?

- A) 116
- B) 118
- C) 126
- D) 180

#10

ID: 69f4bbdc

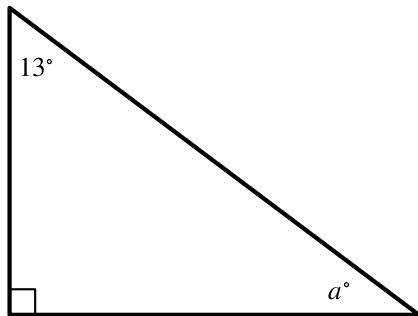

Note: Figure not drawn to scale.

In the right triangle shown, what is the value of  $a$ ?

- A) 13
- B) 77
- C) 90
- D) 103

#11

ID: 3563d76d

At a certain time and day, the Washington Monument in Washington, DC, casts a shadow that is 300 feet long. At the same time, a nearby cherry tree casts a shadow that is 16 feet long. Given that the Washington Monument is approximately 555 feet tall, which of the following is closest to the height, in feet, of the cherry tree?

- A) 10
- B) 20
- C) 30
- D) 35

#12

ID: dfc420b2

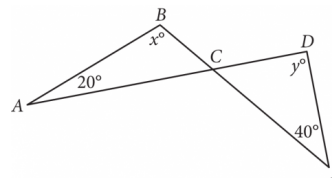

Note: Figure not drawn to scale.

In the figure above,  $\overline{AD}$  intersects  $\overline{BE}$  at C. If  $x = 100$ , what is the value of  $y$ ?

- A) 100
- B) 90
- C) 80
- D) 60

#13

ID: 410bdb6

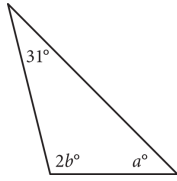

In the triangle above,  $a = 45$ . What is the value of  $b$  ?

- A) 52
- B) 59
- C) 76
- D) 104

#14

ID: a456f28c

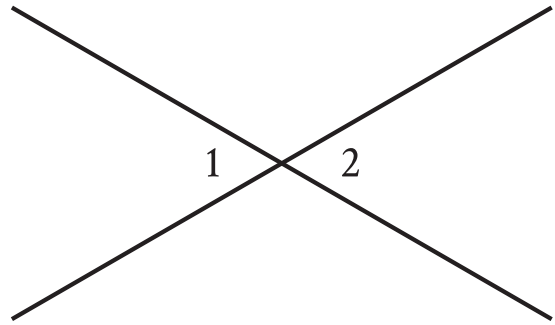

**Note: Figure not drawn to scale.**

In the figure, two lines intersect at a point. Angle 1 and angle 2 are vertical angles. The measure of angle 1 is  $72^\circ$ . What is the measure of angle 2 ?

- A)  $72^\circ$
- B)  $108^\circ$
- C)  $144^\circ$
- D)  $288^\circ$

#15

ID: 087cdcfd

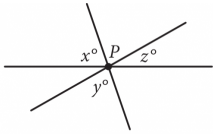

Note: Figure not drawn to scale.

In the figure, three lines intersect at point P. If  $x = 65$  and  $y = 75$ , what is the value of  $z$  ?

- A) 140
- B) 80
- C) 40
- D) 20

#16

ID: afa3c48b

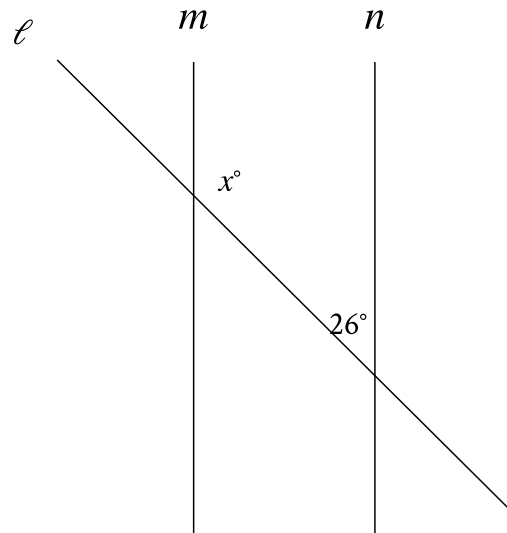

Note: Figure not drawn to scale.

In the figure shown, line  $m$  is parallel to line  $n$ . What is the value of  $x$ ?

- A) 13
- B) 26
- C) 52
- D) 154

#17

ID: 992f4e93

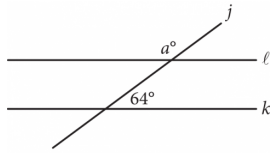

Note: Figure not drawn to scale.

In the figure above, lines  $l$  and  $k$  are parallel. What is the value of  $a$  ?

- A) 26
- B) 64
- C) 116
- D) 154

#18

ID: f1747a6a

In triangle  $ABC$ , the measure of angle  $B$  is  $52^\circ$  and the measure of angle  $C$  is  $17^\circ$ . What is the measure of angle  $A$  ?

- A)  $21^\circ$
- B)  $35^\circ$
- C)  $69^\circ$
- D)  $111^\circ$

#19

ID: 5733ce30

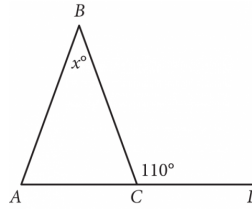

In the given figure,  $\overline{AC}$  extends to point  $D$ . If the measure of  $\angle BAC$  is equal to the measure of  $\angle BCA$ , what is the value of  $x$  ?

- A) 110
- B) 70
- C) 55
- D) 40

#20

ID: 3b4b5b1e

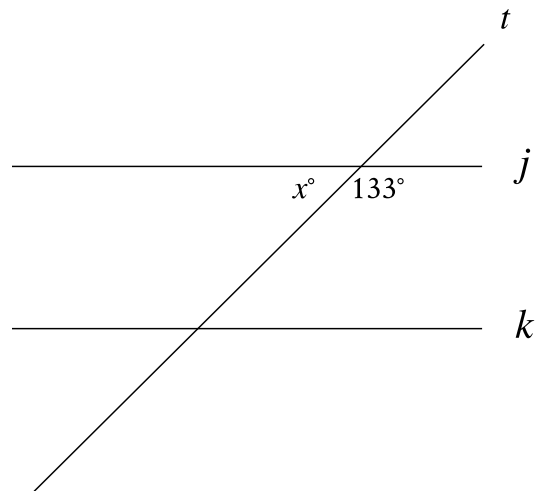

Note: Figure not drawn to scale.

In the figure, line  $j$  is parallel to line  $k$ . What is the value of  $x$  ?

#21

ID: cf0d3050

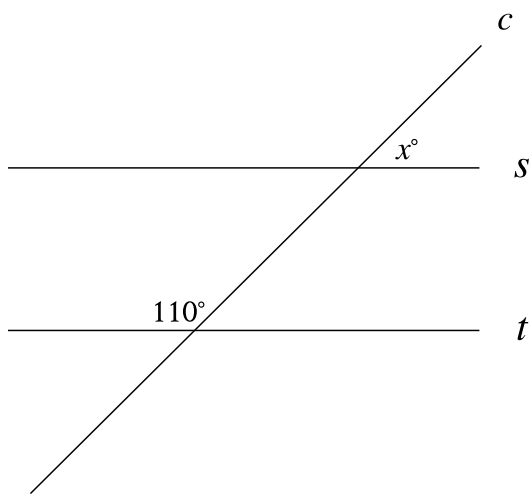

Note: Figure not drawn to scale.

In the figure shown, line  $c$  intersects parallel lines  $s$  and  $t$ . What is the value of  $x$ ?

#22

ID: 0bb39de4

Triangles  $ABC$  and  $DEF$  are congruent, where  $A$  corresponds to  $D$ , and  $B$  and  $E$  are right angles. The measure of angle  $A$  is  $18^\circ$ . What is the measure of angle  $F$ ?

- A)  $18^\circ$
- B)  $72^\circ$
- C)  $90^\circ$
- D)  $162^\circ$

#23

ID: 43236565

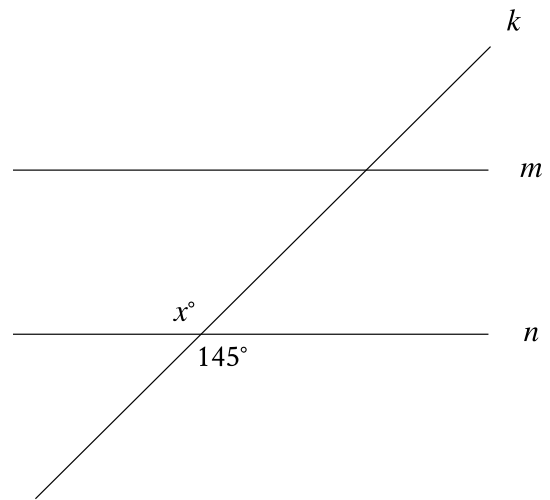

Note: Figure not drawn to scale.

In the figure, line  $m$  is parallel to line  $n$ , and line  $k$  intersects both lines. Which of the following statements is true?

- A) The value of  $x$  is less than 145.
- B) The value of  $x$  is greater than 145.
- C) The value of  $x$  is equal to 145.
- D) The value of  $x$  cannot be determined.



#24

ID: 64d1f49f

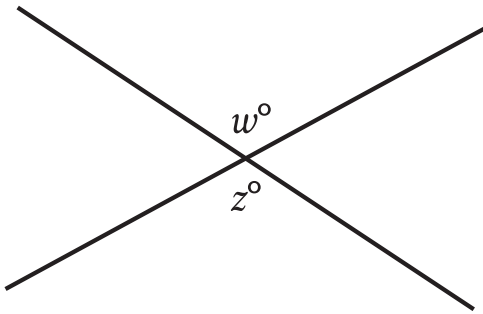

Note: Figure not drawn to scale.

In the figure, two lines intersect at a point. If  $w = 136$ , what is the value of  $z$ ?

- A) 36
- B) 44
- C) 68
- D) 136

#25

ID: 3828f53d

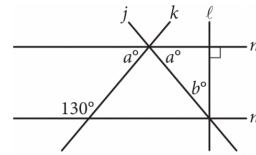

Note: Figure not drawn to scale.

In the figure above, lines  $m$  and  $n$  are parallel. What is the value of  $b$ ?

- A) 40
- B) 50
- C) 65
- D) 80

#26

ID: 739f1bbc

In triangle  $ABC$ ,  $AB = 4,680$  millimeters (mm) and  $BC = 4,680$  mm. Which statement is sufficient to prove that triangle  $ABC$  is equilateral?

- A)  $AC = 4,680$  mm
- B)  $AC = 468$  mm
- C)  $AC = 46.8$  mm
- D)  $AC = 4.68$  mm

#27

ID: 42b4493b

In a right triangle, the measure of one of the acute angles is  $51^\circ$ . What is the measure, in degrees, of the other acute angle?

- A) 6
- B) 39
- C) 49
- D) 51

#28

ID: 36200a38

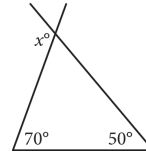

In the figure above, two sides of a triangle are extended. What is the value of  $x$  ?

- A) 110
- B) 120
- C) 130
- D) 140